



KAN-therm
MULTISYSTEM

> 35 | years of experience
on the installation
market



KAN-therm

Inox 304

Install the **future**

SYSTEM KAN-therm Inox 304

1	General information	3
2	System KAN-therm Inox 304	4
2.1	Pipes and fittings – characteristics	4
2.2	Pipe diameters, lengths, weight and capacity	4
2.3	Scope of use	5
3	Sealants – O-Rings	6
4	Durability, resistance to corrosion	7
4.1	Internal corrosion	7
4.2	External corrosion	9
5	Technique of Press joints	9
5.1	Tools	10
5.2	Preparation of pipes for pressing	17
5.3	Pipe bending	21
5.4	Threaded fittings, connecting with other KAN-therm systems	21
6	Flange connections	22
7	Operational notes	22
7.1	Equipotential bonding	22
8	Transport and storage	23
	System KAN-therm Inox 304 - assortment	
	Pipes	24
	Connectors	25
	Accessories	34
	Tools	35

SYSTEM **KAN-therm** Inox 304

1 **General information**

KAN-therm Inox 304 is complete, state-of-the-art installation system consisting of precise pipes and fittings manufactured out of high quality stainless steel. Assembly bases on the "Press" technique, in which fittings are radially pressed over the pipe. Special pressure seals (O-Rings) provide tightness of joints. O-Rings are made of high quality synthetic rubber resistant to high temperatures. A three-angle type "M" pressing system, guarantees reliable, uninterrupted operation of the system. Inox 304 system is used in indoor installations (new and renovated) in housing estates, public buildings and industrial facilities.

KAN-therm Inox 304 system is characterized by:

- easy and quick assembly, without the use of open flame,
- large scope of diameters of pipes and fittings, from 15 to 108 mm,
- broad working temperature tolerance: from -20 °C to 110 °C,
- resistance to high pressure,
- low pressure drops in pipes and fittings,
- possibility of connecting with plastic KAN-therm systems,
- low weight of pipes and fittings,
- resistance to mechanical loads,
- no fire threat during assembly and use (reaction to fire class A),
- esthetic value of installations,
- signaling of mistakenly not-pressed joints in the installation.

2 System KAN-therm Inox 304

2.1 Pipes and fittings – characteristics

KAN-therm Inox 304 pipes and fittings are made of thin-walled alloy steel, chromium-nickel X5CrNi18 10 No. 1.4301, AISI 304.

Fittings are offered with pressed ends and O-Ring seals, or with pressed and threaded ends with female or male threads, according to EN10226-1.

Physical properties of 1.4301 KAN-therm Inox 304 pipes

Property	Symbol	Unit	Value	Remarks
Linear elongation coefficient	α	mm/m × K	0,016	$\Delta t = 1 \text{ K}$
Thermal conductivity	λ	W/m × K	15	
Minimal bending radius	R_{\min}		$3,5 \times D_e$	max. diameter 28 mm
Internal wall roughness	k	mm	0,0015	

2.2 Pipe diameters, lengths, weight and capacity

Scope of diameters Ø15 to Ø108 mm for wall thickness from 1,0 to 2,0 mm.

Pipe length 6 m +5 mm / - 0 mm, end-capped.

Dimensions, weight by unit, water capacity of standard KAN-therm Inox 304 pipes (1.4301)

DN	External diameter × Wall thickness	Wall thickness	Internal diameter	Weight by unit	Length of the bar	Capacity by unit
	mm × mm	mm	mm	kg/m	m	l/m
12	15 × 1,0	1,0	13,0	0,352	6	0,133
15	18 × 1,0	1,0	16,0	0,427	6	0,201
20	22 × 1,2	1,2	19,6	0,627	6	0,302
25	28 × 1,2	1,2	25,6	0,808	6	0,515
32	35 × 1,5	1,5	32,0	1,263	6	0,804
40	42 × 1,5	1,5	39,0	1,527	6	1,195
50	54 × 1,5	1,5	51,0	1,979	6	2,042
65	76,1 × 2,0	2,0	72,1	3,725	6	4,080
80	88,9 × 2,0	2,0	84,9	4,368	6	5,660
100	108 × 2,0	2,0	104,0	5,328	6	8,490

2.3 Scope of use

The scope of application of the KAN-therm Inox 304 installation in the construction industry is determined by the applicable standards - permissible operating pressure up to 16 bar, medium: water and maximum temperature 110 °C.

- open and closed heating systems (water, glycol),
- technological heat installations,
- open and closed chilled water installations (max. dissolved chloride contents 200 mg/l),
- compressed air installations free from oil,
- condensate installations applying the condensation technique for gas fuels (pH 3.5 to 5.2),
- technological installations in the industry.

The use of KAN-therm Inox 304 pipes and fittings outside the scope of indoor heating and cooling installations, e.g. for media of non-typical chemical contents should be consulted with KAN's Technical Support Department (available questionnaire); Please provide i. a. the chemical content of the medium, maximum temperature and operating pressure, as well as ambient temperature in the questionnaire.



Exemplary KAN-therm Inox 304 installation

3 Sealants – O-Rings

KAN-therm Inox 304 pressed fittings are, by standard, equipped with O-Rings made of ethylene-propylene EPDM rubber observing the requirements of EN 681-1. In the case of special applications, Viton O-Rings may be supplied. Working parameters and scopes of use are presented in the table.

Material	Color	Working parameters	Use
EPDM ethylene-propylene rubber	black	<ul style="list-style-type: none"> ■ max working pressure: 16 bar ■ working temperature: -20 °C to +110 °C 	installations: <ul style="list-style-type: none"> ■ central heating ■ technological heat ■ glycol solutions* ■ compressed air (with no oil**)

* It is permissible to use antifreeze solutions based on ethylene and propylene glycols with a maximum concentration of up to 50%, which have been approved by KAN in writing.

** Maximum concentration of synthetic oils up to 5 mg/m³; mineral oils not allowed.

The use of glycol solutions (ethylene and propylene) is allowed as long as they are approved in writing by the manufacturer of the installation system.

If it is necessary to use a lubricant to enable the pipe to be inserted correctly into the fitting socket, water or soap should be used. Do not cover O-Rings with grease, oil or fat. These substances might damage the joints. This also refers to contact with some types of paint used to cover pipes and fittings. Therefore, if it is necessary to paint the installation, only water-based paints should be used.

KAN-therm Inox 304 fittings up to 54 mm are equipped with special LBP O-Rings which guarantees quick detection of not-pressed joints in the installation during the preliminary stage of connecting to water supply (LBP function – Leak Before Press). Such joints are signaled by water leaks at a point of connection. To ensure a fully functional and tight joint, after locating the leak, just press the joint.

For elements above 54 mm, LBP function is performed by fitting specific shape.



1. O-Ring action with the LBP function of leakage detection

4 Durability, resistance to corrosion

Installation technology distinguishes various types of corrosion: chemical, electrochemical, internal or external, spot corrosion, corrosion produced by stray currents, etc. Such phenomena may be caused by specific physical and chemical factors related to the quality of installation materials, parameters of conducted media, external conditions, as well as the structure of the installation. Below, we present a few guidelines to be taken into account when designing, assembling and using KAN-therm Inox 304 installations in order to avoid undesirable corrosive phenomena in metal installations.

The probability of occurrence of metal corrosion caused by stray currents (direct current passing through the pipeline material to the ground, disrupting the natural insulation layers, such as walls, pipe shields, etc.) is very small. This phenomenon is additionally reduced by introducing equipotential connections to the installation.

4.1 Internal corrosion

Stainless steel is resistant to nearly all components of the media transported in installations. Pay special attention to chlorides dissolved in water (halogens), since their action depends on their concentration and temperature (max 200 mg/l at 20 °C). No elements should be subjected to contact with highly concentrated ions of dissolved chlorides in temperatures above 50 °C. This is why you should:

- avoid sealants containing halogens which could dissolve in water (use plastic sealing tape, e.g. PARALIQ PM 35),
- local water heating by increased pipe wall temperature (e.g. heating cables in water supply installations) may lead to the precipitation of sediments on the internal surface of pipes, including chloride ions, which increase the risk of pit corrosion. In such case, the temperature of pipe wall should not exceed 60 °C permanently. Periodic (max 1 hour a day) water heating up to 70 °C for the purpose of thermal disinfection is permissible.

Direct connections of stainless steel elements with zinc-plated steel (fixtures, fittings) may result in contact corrosion of zinc-plated steel. Therefore, a bronze or brass element (e.g. coupling) of at least 50 mm must be used.

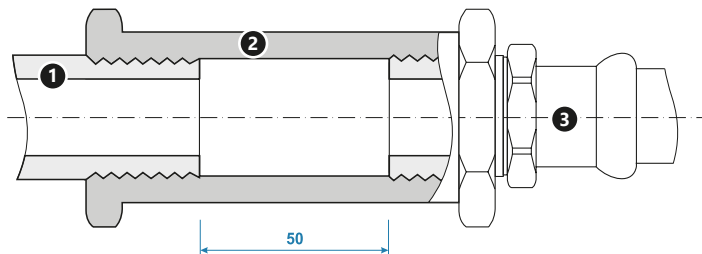

Principle of connecting KAN-therm Inox 304 elements with zinc-plated steel
1. Steel pipe zinc-plated
2. Bronze or brass
3. Fitting with a KAN-therm Inox 304 thread

It is also acceptable to make separable flange connections:

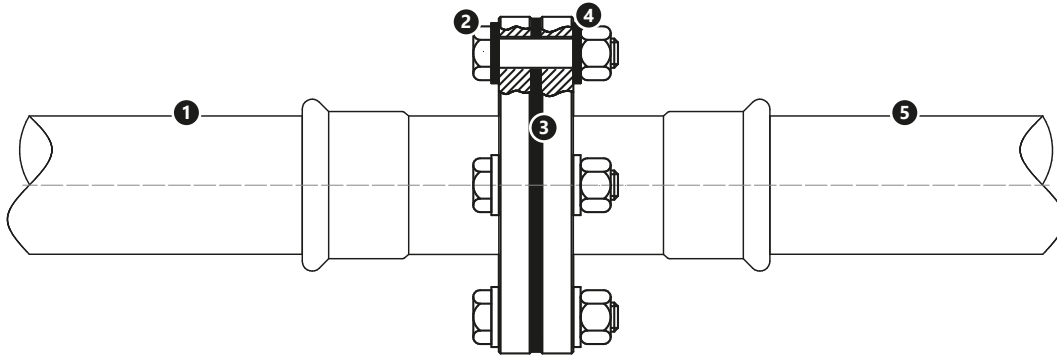

Case I:

- 1. KAN-therm Inox 304 system,
- 2. stainless steel flange bolt and nut
- 3. elastomer or fibre sealing
- 4. metal washer with plastic casing
- 5. Traditional carbon steel system.

Case II:

- 1. KAN-therm Inox 304 system,
- 2. stainless steel flange bolt and nut
- 3. elastomer or fibre sealing
- 4. metal washer with plastic casing
- 5. Traditional copper system.



Remember that all of the above flange connections use bolts and nuts joining flanges made of stainless steel.

In KAN-therm Inox 304 system, the is a possibility of using other materials (with intermediate elements, such as threaded or collar joints) depends on the type of installation.

Possibility of connecting KAN-therm Inox 304 system with other elements

Installation type	Pipes/fittings				
	Copper	Bronze/Brass	Carbon steel	Stainless steel	
Inox 304	closed	yes	yes	yes	yes
	open	yes	yes	no	yes

4.2 External corrosion

External corrosion of elements of the KAN-therm Inox 304 system can occur when pipes or fittings are in a humid environment containing or producing compounds of chlorine or other halogens. Corrosion processes are intensified at temperatures above 50 °C.

Moreover, KAN-therm Inox 304 system components can be installed and operated in environments with a corrosion class not higher than C3 according to EN ISO 12944-2.

Therefore, in situations such as:

- contact with building components (e.g. mortar, insulation) emitting chlorine compounds,
- environment containing chlorine or its compounds in gaseous form or water containing salt (brine) or other halogen compounds,
- KAN-therm Inox 304 system applications in environments with corrosion class C4 and higher,

it is necessary to use full, watertight and non-absorbent waterproofing made of material with a closed cell structure that does not emit chlorides and halides. The dissolved chlorine ion content of the insulation materials must not exceed 0.05%. Thermal insulation should comply with current regulations and standards.

If there is a risk of mechanical damage to the external insulations then these must be adequately protected, for example, with protective steel coating.

5 Technique of Press joints

KAN-therm Inox 304 system is based on the "Press" technique of executing joints, utilizing M-profiled jaws.

This technique allows:

- applying three-angle pressure on the O-Ring, which ensures its correct deformation and adhesion to the pipe surface,
- fully enclosing the inner space, in which the O-Ring is settled – through screwing the edge of the fitting onto the surface of the pipe, which prevents pollutions from penetrating the interior of the fitting. Such structure serves as a natural mechanic shield to the seal and reinforcement to the joint,
- controlling the state of the joint through the structure of the O-Ring socket in the vicinity of the fitting edge.

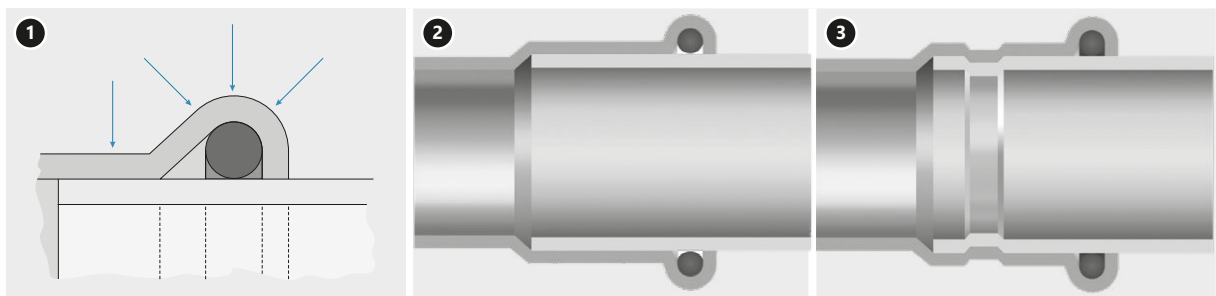

1. Pressure directions in a "Press" joint
2. Cross-section of a joint before pressing
3. Cross-section of the joint after pressing

5.1 Tools

In order to ensure a correct, water-tight connection, use proper tools. We suggest the use of cutters, deburrers and press machines as well as jaws offered by the KAN-therm system. There is a possibility of using other tools recommended by KAN (see table below).

To perform connections in KAN-therm Inox 304, use tools available in KAN-therm system offer - see the table below.

Producer	Press type		Diameter [mm]	Jaws/collars		Adapter		Type of KAN-therm system		
	Description	Code		Description	Code	Description	Code	Inox 304		
KAN-therm	AC 3000 DC 4000	1936267239 1936267238	15	M	1936267249	-	-	+		
			18	M	1936267250	-	-	+		
			22	M	1936267251	-	-	+		
			28	M	1936267252	-	-	+		
			35	M	1936267253	-	-	+		
			42	M	1936267283			+		
			54	M	1936267284	ZBS1	1936267285	+		
	ACO203XL EFP 203 ¹⁾	1948267181 1948267210	15 ¹⁾	[J] M	1948267135	-	-	+		
			18 ¹⁾	[J] M	1948267137	-	-	+		
			22 ¹⁾	[J] M	1948267139	-	-	+		
			28 ¹⁾	[J] M	1948267141	-	-	+		
			35 ¹⁾	[J] M	1948267143	-	-	+		
			35 ¹⁾	HP Snap On	1948267124			+		
			42 ¹⁾	M Snap On	1948267119			+		
			42 ¹⁾	HP Snap On	1948267126	ZB203	1948267000	+		
54 ¹⁾			M Snap On	1948267121			+			
66,7			M Snap On	1948267089			-			
76,1			M Snap On	1948267145	ZB221	1948267005	+			
88,9			M Snap On	1948267044			+			
108			M Snap On	1948267038	ZB221 ZB222	1948267005 1948267007	+			
NOVOPRESS			ACO102 * ACO103	1948055007 1948055008	15	[J] M	1948267093	-	-	+
					18	[J] M	1948267095	-	-	+
					22	[J] M	1942121002	-	-	+
					28	[J] M	1948267097	-	-	+
					35	[J] M	1942121004	-	-	+
	ECO301 *	1948267163 *	15	[J] M	1948267085	-	-	+		
			18	[J] M	1948267087	-	-	+		
			22	[J] M	1944267008	-	-	+		
			28	[J] M	1944267011	-	-	+		
			35	HP Snap On	1948267124			+		
			42	HP Snap On	1948267126	ZB 303	1948267166	+		
			54	HP Snap On	1948267128			+		
	ACO401 * ACO403	1948267151 1948267209	76,1	HP Snap On	1948267100	-	-	+		
			88,9	HP Snap On	1948267102	-	-	+		
			108	HP Snap On	1948267098	-	-	+		
REMS Power-Press SE Akku-Press Power-Press ACC	1936267160 1936267152 1936267219	15	[J] M	1948267048	-	-	+			
		18	[J] M	1948267052	-	-	+			
		22	[J] M	1948267056	-	-	+			
		28	[J] M	1948267061	-	-	+			
		35	[J] M	1948267065	-	-	+			
		42	[J] M	1948267067	-	-	+			
		54	[J] M	1948267069	-	-	+			

Producer	Press type		Diameter [mm]	Jaws/collars		Adapter		Type of KAN-therm system
	Description	Code		Description	Code	Description	Code	Inox 304
KLAUKE	KAN-therm Mini	1936055008	15	M	1936267278	-	-	+
			18	M	1936267279	-	-	+
			22	M	1936267280	-	-	+
			28	M	1936267282	-	-	+

[J] - two segment jaw, other elements are collars / slings and may require cooperation with an adapter.

1) Limited diameter range - use selected press jaws

* The tools are not available in KAN-therm Inox 304 offer.

Other commonly available tool models on the market can also be used for the installation of the KAN-therm Inox 304 system; see the table below:

Size	Producer	Press type	Jaws/collars
15–35 mm	Novopress	<ul style="list-style-type: none"> ■ ACO102 (12 V) ■ ACO103 (12 V) 	<ul style="list-style-type: none"> ■ PB1 jaws 15–35 mm
15–54 mm	Novopress	<ul style="list-style-type: none"> ■ ACO 203 (18 V) ■ EFP 201/202 (230 V) ■ EFP 203 (230 V) 	<ul style="list-style-type: none"> ■ PB2 jaws 15–35 mm ■ Collars and adapters 35–54 mm: <ul style="list-style-type: none"> • collars: HP35, 42 and 54 (with adapter ZB 201/ZB 203) • Snap On collars: HP35, 42 and 54 (with adapter ZB 201) • Snap On collars: HP35, HP42 and HP54 (with adapter ZB 203)
15–108 mm	Novopress	<ul style="list-style-type: none"> ■ ECO 3 Pressmax (230 V) ■ ECO 301 (230 V) 	<ul style="list-style-type: none"> ■ PB3 jaws: 15–28 mm ■ Collars and adapters (ZB 302/ZB 303) 35–54 mm: <ul style="list-style-type: none"> • collars: HP35, 42 and 54 (with adapter ZB 302/ZB 303) • Sling On collars: HP42 and HP54 (with adapter ZB 302) • Snap On collars: HP35, HP42 and HP54 (with adapter ZB 303) ■ Collars and adapters 76,1–108 mm: <ul style="list-style-type: none"> • collars M66,7–88,9 mm (adapter ZB 323) • Snap On collar M 108 mm (two adapters required: ZB 323 and ZB 324) • Sling On collars M 76,1–88,9 mm (adapter ZB321) • Sling On collars M108 (two adapters required: ZB321 and ZB322) <p>IMPORTANT: Press in two stages (108 mm).</p>
76,1–108 mm	Novopress	<ul style="list-style-type: none"> ■ ACO 401 (18 V) ■ ACO 403 (18 V) 	<ul style="list-style-type: none"> ■ Snap On collars HP76,1–108 mm
15–22 mm	Klauke	<ul style="list-style-type: none"> ■ MAP215 "Klauke Mini" (18 V) 	<ul style="list-style-type: none"> ■ Mini Klauke jaws: 15–22 mm
15–35 mm	Klauke	<ul style="list-style-type: none"> ■ MAP219 "Klauke Mini" (18 V) 	<ul style="list-style-type: none"> ■ Mini Klauke jaws: 15–35 mm
15–54 mm	Klauke	<ul style="list-style-type: none"> ■ Klauke UAP332 	<ul style="list-style-type: none"> ■ Jaws: 15–54 mm
15–108 mm	Klauke	<ul style="list-style-type: none"> ■ UAP432 (18V) 	<ul style="list-style-type: none"> ■ Jaws: 15–54 mm (KSP3) ■ Collars and adapters: 42–54 mm (KSP3) ■ Collars and adapters: 76,1–168 mm (LP – KSP3)
76–108 mm	Klauke	<ul style="list-style-type: none"> ■ UAP100120 (18 V) 	<ul style="list-style-type: none"> ■ Collars: 66,7–108 mm (KSP3)
15-35 mm	Hilti	<ul style="list-style-type: none"> ■ NPR 019 IE-A22 	<ul style="list-style-type: none"> ■ NPR PM jaws: 15-35 mm
15-54 mm	Hilti	<ul style="list-style-type: none"> ■ NPR 032 IE-A22 	<ul style="list-style-type: none"> ■ NPR PS jaws: 15-35 mm ■ NPR PR collars: 42-54 mm
15-108 mm	Hilti	<ul style="list-style-type: none"> ■ NPR 032 PE-A22 	<ul style="list-style-type: none"> ■ NPR-PS jaws: 15-35 mm ■ NPR PR jaws with adapter 42-88,9 mm (with NPR PA3 adapter), 108 mm (with NPR PA3+NPR PA4 adapter) <p>IMPORTANT: press in two stages (108 mm)</p>
15-108 mm	Hilti	<ul style="list-style-type: none"> ■ M18HPT XL 	<ul style="list-style-type: none"> ■ Jaws: 15-108 mm
15-35 mm	Milwaukee	<ul style="list-style-type: none"> ■ M12 HPT-202C 	<ul style="list-style-type: none"> ■ J12 jaws: 15-35 mm
15-54 mm	Milwaukee	<ul style="list-style-type: none"> ■ M18 HPT-202C 	<ul style="list-style-type: none"> ■ J18 jaws: 15-35 mm ■ RJ collars: 42-54 mm (with RJA adapter)
15–35 mm	REMS	<ul style="list-style-type: none"> ■ Mini Press ACC (14V) ■ Mini Press ACC (22V) 	<ul style="list-style-type: none"> ■ REMS Mini Press jaws: 15–35 mm*

Size	Producer	Press type	Jaws/collars
15–54 mm	REMS	<ul style="list-style-type: none"> ■ Powerpress 2000 (230 V) ■ Powerpress E (230 V) ■ Powerpress ACC (230 V) ■ Accu-Press (12 V) ■ Accu-Press ACC (12 V) 	<ul style="list-style-type: none"> ■ REMS jaws: 15–54 mm* (4G) ■ Collars and adapter: 42–54 mm (PR3-S)
15–108 mm	REMS	<ul style="list-style-type: none"> ■ Power-Press XL ACC 	<ul style="list-style-type: none"> ■ REMS jaws: 15–35 mm (2G) ■ REMS jaws: 42 mm (4G) ■ Collars and adapter: 42 mm (PR-3S + Z2) ■ REMS jaws: 54 mm (4G) ■ Collars and adapter: 54 mm (PR-3S + Z2) ■ Collars and adapter: XP66,7 mm (PR-3S + Z6 XL) ■ Collars and adapter: 76,1–108 mm (PR-3S + Z6 XL)
15–54 mm	Rothenberger	<ul style="list-style-type: none"> ■ Romax AC ECO ■ Romax 3000 Akku ■ Romax 3000 AC ■ Romax 4000 	<ul style="list-style-type: none"> ■ KAN-therm jaws M15–35 mm ■ KAN-therm collars M42–54 with adapter (ZBS1)

* only 18 and 28 mm forks marked as "108" (Q1 2008) or newer allowed

Utilization of other press tools requires consultation with the manufacturer of the installation system each time.



Tools – work safety

Before starting any works, make sure you read the instruction manual and learn the principles of safe work. All tools must be used according to their dedication and the manufacturer's instruction manual. During the use of tools, one must observe the terms of regular inspections and all applicable safety regulations. Using tools against their designed use may lead to their damage or to the damage of their accessories and pipes. It may also lead to the occurrence of leakages in installation joints.

KAN-therm tools:



1. Electric press KAN-therm AC 3000
2. Battery-powered press KAN-therm DC 4000
3. KAN-therm M15–35 mm jaws
4. M42-54 mm collar
5. ZBS1 42-54 mm adapter

NOVOPRESS tools:



1. Battery-powered press ACO203XL
2. PB2 M15–35 mm jaws
3. M 35–108 Snap On collar
4. ZB203 adapter
5. ZB221, ZB222 adapters



1. Electric press EFP203
2. PB2 M15-35 mm jaws
3. M 35-54 Snap On collar
4. ZB203 adapter



1. Battery-powered press ACO 102*
 2. Battery-powered press ACO 103
 3. M15-35 mm jaws
- *The tools are not available in KAN-therm offer.



1. Electric press ECO 301*
 2. M15-28 mm jaws
 3. M 35-66,7 Snap On collar
 4. ZB 303 adapter
 5. ZB 323 adapter
- *The tools are not available in KAN-therm offer.



1. Battery-powered press ACO 401*/ACO 403
 2. HP 76,1-108 Snap On collar
- *The tools are not available in KAN-therm offer.

REMS tools:



1. Electric press Power-Press ACC
2. Battery-powered press Akku-Press
3. Electric press Power-Press SE
4. M15–35 mm jaws
5. M42–54 mm jaws

KLAUKE tools:



1. Battery-powered press KAN-therm Mini
2. SBM M 15–28 mm jaws

5.2 Preparation of pipes for pressing



1. Cutting pipes

Cut pipes perpendicularly to the axis using a roll pipe cutter (breaking incompletely cut pipe sections is prohibited). The use of other tools is permitted, provided that the cut is made perpendicularly and the cut edges are not damaged in the form of cracks, material loss, or other deformations of the pipe cross-section. Do not use torches or cutting discs for pipe cutting, which can generate significant amounts of heat, angle grinders, etc.



2. Chamfering

Use a manual chamfer (for diameters 76,1–108 – a semi-round steel file) to chamfer the internal and external edge of the pipe, removing all chips, which could potentially damage the O-Ring during assembly.

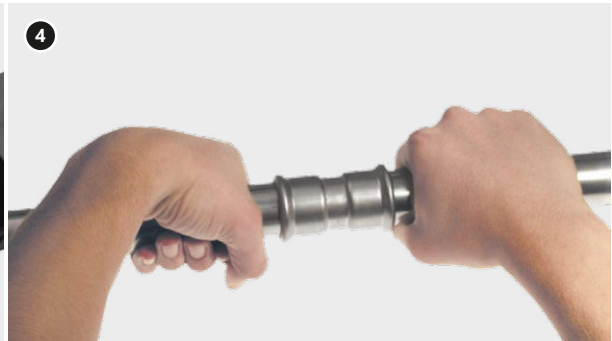

3. Inspection

Prior to assembly, visually inspect the presence and condition of the O-Ring. Check, if there are no chips or metal shavings or other pollutions on the pipe and the fitting, which could damage the seal during installation. Make sure if the distance between neighboring fittings is above the permissible d_{\min} (table: Minimal assembly distances, fig. 1).

4. Mounting the pipe and the joint

To achieve the correct strength of a joint, ensure a proper depth A (table: Minimal assembly distances, fig. 1) of inserting the pipe into the fitting.

Before pressing, insert the pipe into the fitting up to the marked depth (slight rotation permissible). Do not use lubricants, greases or fats when mounting the pipe (water or a soap solution is permissible – recommended for pressure tests conducted with compressed air).



5. Marking the depth of the mount

In order to ensure the correct durability of your joint, maintain proper depth A (table: Minimal assembly distances) of mount of the pipe inside the fitting. When mounting multiple joints at the same time (sliding pipes into fittings), before pressing next joints, inspect the pipe insertion depth. To do this, just check if the pipe is inserted into the fitting as far as possible.

To facilitate the identification of the pipe insertion depth in the fitting, use a simple technique of marking with a marker. It consists in sliding the pipe into the fitting as far as possible and then making a mark on the pipe, right next to the very edge of the fitting socket. After pressing, this mark must still be visible right at the edge of the fitting.

You can also use special patterns to mark the sliding depth without checking it with the fitting.

Note: The patterns to mark the sliding depth are not part of the basic system offer and may be available depending on the markets where the product is sold.



6. Pressing joints

Before starting any works, read all suitable instruction manuals and verify the proper operation of your tools. It is recommended to use pressing tools and jaws offered as part of the KAN-therm Inox 304 system.

Select the size of your press jaw basing on the diameter of the joint. Place the jaws on the joint so that its notch embraces the protruding part of the fitting (the space where the O-Ring is located). After starting the press, the process takes place automatically and cannot be stopped. If, for any reason, the process of pressing is stopped, the joint needs to be disassembled (cut off) and a new one needs to be executed. If the installer has press tools and jaws not supplied by the KAN-therm, the possibility of using them should be consulted with KAN's Technical Support Department.



7. Pressing 76,1–108 mm joints - preparing the jaws

To press the biggest diameters (76,1; 88,9; 108), use a special, four-part jaw (collar). After taking the jaws out of the box, unlock it. Next, open the jaws.

8. Mount the opened jaws on the fitting. The jaws are equipped with a special notch, which fits the collar on the fitting.

Notice: A label with the size of the jaws (visible on the figure) should be always located at the side of the pipe.

9. After the jaw is properly located on the fitting, it should be secured again by pressing the pin as far as possible (Klauke collars) or checking the alignment of the markers (Novopress collars). At this moment, the jaws are ready to be connected to the press machine.



10. Connecting the press machine to the jaws

Connect the press tool to the collar. It is absolutely necessary to ensure that the press tool is connected to the collar in accordance with the instructions attached to the specific tool.

A press machine connected this way may be started for the purpose of executing a fully pressed joint.

11. Pressing

The full time of executing one pressed joint is c.a. 1 min. (applies to diameters: 76,1–108 mm). After starting the press, the process takes place automatically and cannot be stopped. If, for any reason, the process of pressing is stopped, the joint needs to be disassembled (cut off) and a new one needs to be executed. After executing the pressed joint, the press machine will automatically return to its primary position. After that, remove the arms of the press machine from the jaws. To remove the collar from the fitting, unlock it again and then unfold it.

Pipe insertion depth in the fitting and minimum distance between pressed fittings

\varnothing [mm]	A [mm]	d_{\min} [mm]	C_{\min} [mm]
15	20	10	35
18	20	10	35
22	21	10	35
28	23	10	35
35	26	10	35
42	30	20	35
54	35	20	35
76,1	53	20	75
88,9	60	20	75
108	71	20	100

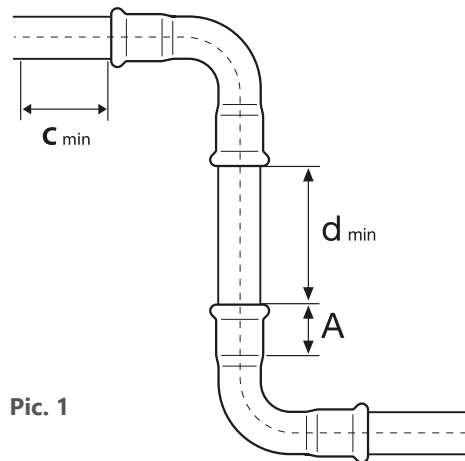

Pic. 1

- A – Pipe insertion depth in the fitting,
- d_{\min} – minimum distance between fittings allowing press correctness
- C_{\min} – minimal distance of fitting from wall

Minimal assembly distances

\varnothing [mm]	C [mm]	D [mm]	E [mm]	F [mm]
Jaws				
15	20	28	75	130
18	25	28	75	131
22-28	31	35	80	150
35	31	44	80	170
54	60	110	140	360
Collars				
42	75	75	115	265
54	85	85	120	290
76,1	110	110	140	350
88,9	120	120	150	390
108	140	140	170	450

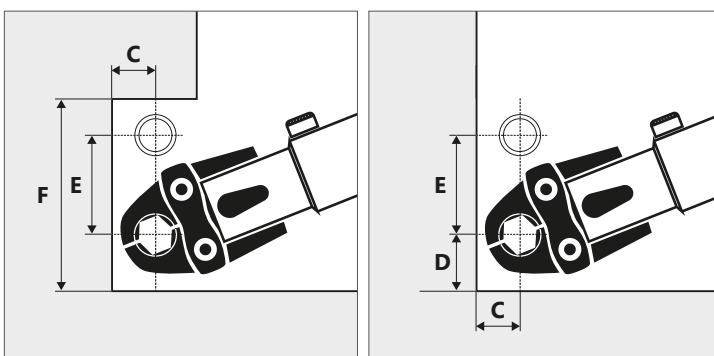

5.3 Pipe bending

If there is a need, KAN-therm Inox 304 pipes may be bent "cold", provided that the minimal bending radius R_{\min} is observed:

$$R_{\min} = 3,5 \times D_e$$

D_e – external diameter of the pipe

Do not bend the pipes "hot", due to the vulnerability of pipes processed this way to corrosion resulting from a change in the crystal structure of their material.

Use manual benders to bend the pipe. These may be electric or hydraulic. Do not "cold" bend pipes with diameters exceeding $\varnothing 35$ mm (use ready-made bends and elbows 90° and 45° supplied as part of the KAN-therm system).

Do not weld or solder KAN-therm Inox 304 pipes, since this process changes the structure of material, which might lead to corrosion.

5.4 Threaded fittings, connecting with other KAN-therm systems

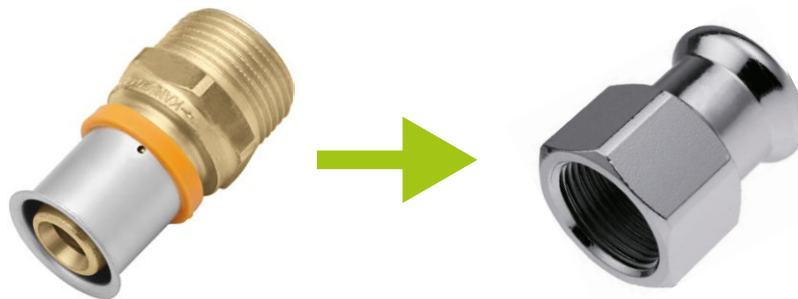

The principle of connecting KAN-therm Inox 304 joints with brass fittings

KAN-therm Inox 304 system offer a wide selection of fittings with male and female threads. Since fittings with male threads are equipped with cone threads (pipe), in threaded joints with brass shape fittings, you can only use male threads for brass joints, sealed with e.g. a small amount of tow. It is suggested that the threaded (screwed) joint is executed before pressing the joint, so that no additional load is applied on the pressed joint. Do not use standard PTFE tape or any other solutions containing halides (e.g. chlorides) to seal threads in KAN-therm Inox 304 installations.

Threaded fittings with other fixtures and threaded elements outside the system KAN-therm offer should be made in line with EN 10226 (ISO 7-1) and EN ISO 228 depending on the thread type.

6 Flange connections



Table of Inox 304 flange connections

Code	Size	Amount of screws/nuts	Screw size	Screw class	Nut class	Amount of washers	Flange	Flat seal
1609091030	15 DN15 PN16	4	M12	8.8	8	8	DN15	DN12 EPDM
1609091031	18 DN15 PN16	4	M12	8.8	8	8	DN15	DN15 EPDM
1609091032	22 DN20 PN16	4	M12	8.8	8	8	DN20	DN20 EPDM
1609091033	28 DN25 PN16	4	M12	8.8	8	8	DN25	DN25 EPDM
1609091034	35 DN32 PN16	4	M16	8.8	8	8	DN32	DN32 EPDM
1609091035	42 DN40 PN16	4	M16	8.8	8	8	DN40	DN40 EPDM
1609091036	54 DN50 PN16	4	M16	8.8	8	8	DN50	DN50 EPDM
1609091037	76,1 DN65 PN16	4	M16	8.8	8	8	DN65	DN65 EPDM
1609091038	88,9 DN80 PN16	8	M16	8.8	8	16	DN80	DN80 EPDM
1609091029	108 DN100 PN16	8	M16	8.8	8	16	DN100	DN100 EPDM

7 Operational notes

7.1 Equipotential bonding

Every finished metal installation has to be provided with connections equalizing electrical potentials, i.e. grounded in order to prevent stray currents and occurrence of contact corrosion.

According to regulations in force, the connections of grounding conductors have to be made by welding or by threaded clamps and the connections to the pipelines must be made with screw clamps. In order to make the correct equipotential bonding, it is necessary to:

1. Get information on the applied electric shock protection solution (grounding method) in the building object.
2. Connect the equalizing conduit to the pipe with the appropriate clamp. In order to eliminate the risk of contact corrosion, the clamp must be selected according to the type of pipe.
3. Make the serial connections of all individual pipelines branches with a use of potentials equalization conduits and connect them to the main grounding collecting bar of the building object.



Attention!

Remove the insulation, paintwork and dirt from the pipe in clamp assembly places.

The length of the electrical conduits from the piping system to the grounding collecting bar of the potential equalization system should be as short as possible.

Calculations of the electrical potentials equalization system in the building object must be performed by person with appropriate qualifications.

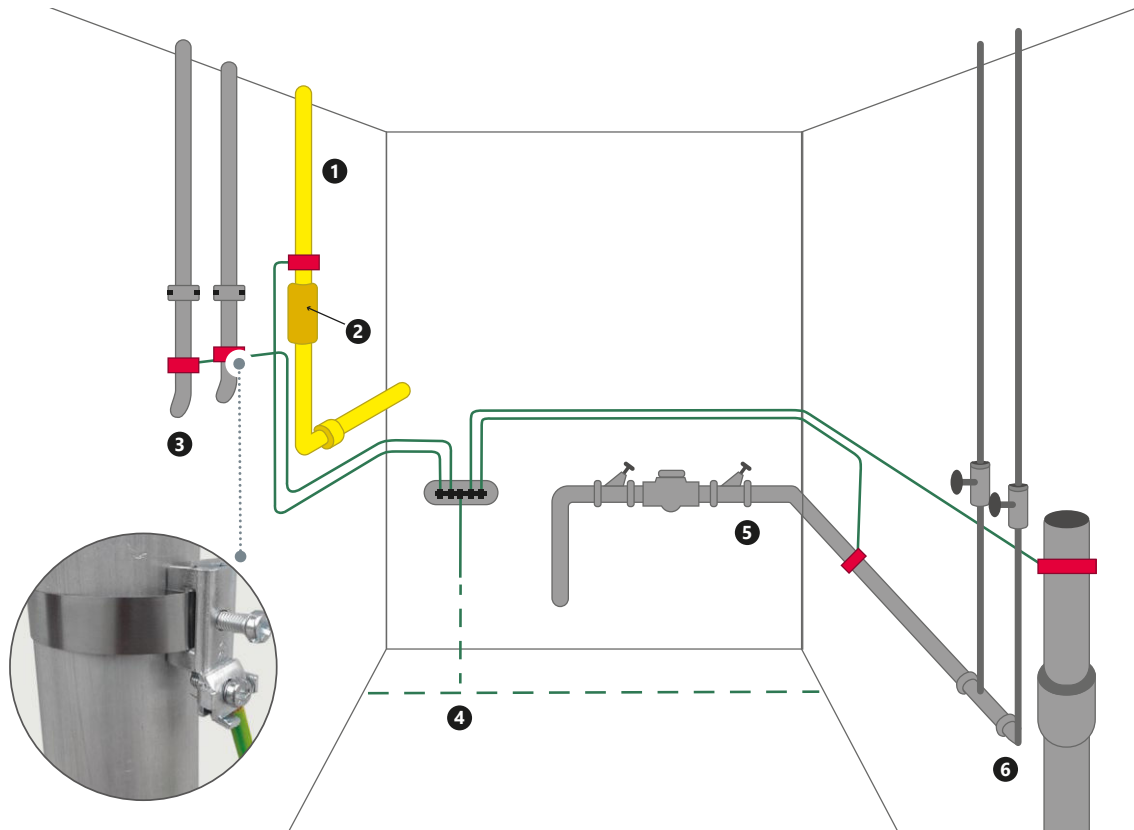

1. Gas
2. Insulation liner
3. Central heating
4. Foundation grounding
5. Water
6. Sewer

8 Transport and storage

- Elements of the KAN-therm Inox 304 must be stored separately from other metal elements such as carbon steel.
- Do not store elements of the system directly on the ground (e.g. on soil or concrete).
- Do not store elements of the system in the vicinity of chemical solutions.
- Pipe bundles should be stored and transported on wooden pallets (avoid direct contact with other steel elements, e.g. pipe stands).
- During transport, loading and unloading, be extra careful not to scratch or damage the pipes or fittings – do not: throw, drag or bend them.
- Rooms designed for storing elements of the system must be dry.
- During their storage, assembly and use, pipe surfaces must not be exposed to long-term, direct contact with water or humidity.



Detailed information about storage and transport of components can be found at en.kan-therm.com.



SYSTEM KAN-therm Inox 304 - assortment

Pipes



Stainless steel pipe 1.4301 - bar

GROUP: H

Size [mm]	*	Code			UM
15×1,0		1629194048	6	762	m
18×1,0		1629194049	6	366	m
22×1,2		1629194050	6	366	m
28×1,2		1629194051	6	222	m
35×1,5		1629194052	6	222	m
42×1,5		1629194053	6	114	m
54×1,5		1629194054	6	114	m
76,1×2,0		1629194055	6	144	m
88,9×2,0		1629194056	6	96	m
108×2,0		1629194047	6	78	m

Note:

Operating pressure depends on the type of transported medium, diameter range, type of pipes and tools used to make connections:



■ 15-108 mm up to 16 bar (tools with jaws with M profile).

Not applicable to compressed air systems - refer to the "Designer and Contractor Guidebook" for operating conditions.

Connectors

Female connector 1.4301



GROUP: G

	Size [mm]	*	Code			UM
N	15 Rp $\frac{3}{8}$ "		1609044033	20	90	pc.
N	15 Rp $\frac{1}{2}$ "		1609044016	20	130	pc.
N	15 Rp $\frac{3}{4}$ "		1609044017	20	90	pc.
N	18 Rp $\frac{1}{2}$ "		1609044018	20	120	pc.
N	18 Rp $\frac{3}{4}$ "		1609044019	20	80	pc.
N	22 Rp $\frac{1}{2}$ "		1609044021	20	100	pc.
N	22 Rp $\frac{3}{4}$ "		1609044022	20	100	pc.
N	22 Rp1"		1609044020	20	60	pc.
N	28 Rp $\frac{3}{4}$ "		1609044025	20	40	pc.
N	28 Rp1"		1609044024	20	60	pc.
N	28 Rp1 $\frac{1}{4}$ "		1609044023	20	30	pc.
N	35 Rp1"		1609044028	10	20	pc.
N	35 Rp1 $\frac{1}{4}$ "		1609044027	10	30	pc.
N	35 Rp1 $\frac{1}{2}$ "		1609044026	10	20	pc.
N	42 Rp1 $\frac{1}{4}$ "		1609044030	4	12	pc.
N	42 Rp1 $\frac{1}{2}$ "		1609044029	4	24	pc.
N	54 Rp1 $\frac{1}{2}$ "		1609044031	4	12	pc.
N	54 Rp2"		1609044032	4	12	pc.
N	76,1 Rp2 $\frac{1}{2}$ "		1609044034	1	1	pc.
N	88,9 Rp3"		1609044035	1	1	pc.



Male connector 1.4301

GROUP: G

	Size [mm]	*	Code			UM
N	15 R $\frac{3}{8}$ "		1609045098	20	80	pc.
N	15 R $\frac{1}{2}$ "		1609045096	20	200	pc.
N	15 R $\frac{3}{4}$ "		1609045097	20	80	pc.
N	18 R $\frac{1}{2}$ "		1609045099	20	160	pc.
N	18 R $\frac{3}{4}$ "		1609045100	20	100	pc.
N	22 R $\frac{1}{2}$ "		1609045102	20	70	pc.
N	22 R $\frac{3}{4}$ "		1609045103	20	100	pc.
N	22 R1"		1609045101	20	60	pc.
N	28 R $\frac{3}{4}$ "		1609045106	20	50	pc.
N	28 R1"		1609045105	20	60	pc.
N	28 R1 $\frac{1}{4}$ "		1609045104	20	30	pc.
N	35 R1"		1609045109	10	40	pc.
N	35 R1 $\frac{1}{2}$ "		1609045107	10	20	pc.
N	35 R1 $\frac{1}{4}$ "		1609045108	10	40	pc.
N	42 R1 $\frac{1}{2}$ "		1609045110	4	24	pc.
N	42 R1 $\frac{1}{4}$ "		1609045111	4	24	pc.
N	54 R1 $\frac{1}{2}$ "		1609045112	4	16	pc.
N	54 R2"		1609045113	4	12	pc.
N	76,1 R2 $\frac{1}{2}$ "		1609045114	1	1	pc.
N	88,9 R3"		1609045115	1	1	pc.
N	108 R4"		1609045125	1	1	pc.



 coil
  bar
  pipes in tube
  bag
  carton box
  pallet
 N new
  available soon

* custom-made - lead time max 4 weeks | ** availability as agreed | *** while stock lasts



Female half union with flat sealing 1.4301

GROUP: G

	Size [mm]	*	Code							UM
N	15 G $\frac{1}{2}$ "		1609271074	20				120		pc.
N	15 G $\frac{3}{4}$ "		1609271063	10				120		pc.
N	18 G $\frac{1}{2}$ "		1609271075	20				100		pc.
N	18 G $\frac{3}{4}$ "		1609271064	20				100		pc.
N	22 G $\frac{3}{4}$ "		1609271076	20				60		pc.
N	22 G1"		1609271065	20				60		pc.
N	28 G1"		1609271077	20				40		pc.
N	28 G1 $\frac{1}{4}$ "		1609271066	20				40		pc.
N	35 G1 $\frac{1}{4}$ "		1609271078	10				32		pc.
N	35 G1 $\frac{1}{2}$ "		1609271067	10				32		pc.
N	42 G1 $\frac{3}{4}$ "		1609271079	4				12		pc.
N	42 G2"		1609271080	4				12		pc.
N	54 G2"		1609271081	4				8		pc.



Straight coupling 1.4301

GROUP: G

	Size [mm]	*	Code							UM
N	15		1609245054	20				140		pc.
N	18		1609245055	20				120		pc.
N	22		1609245056	20				80		pc.
N	28		1609245057	20				60		pc.
N	35		1609245058	10				35		pc.
N	42		1609245059	4				24		pc.
N	54		1609245060	4				16		pc.
N	76,1		1609245061	1				1		pc.
N	88,9		1609245062	1				1		pc.
N	108		1609245052	1				1		pc.



Slip coupling 1.4301

GROUP: G

	Size [mm]	*	Code							UM
N	12		1609080041	20				140		pc.
N	15		1609080042	20				140		pc.
N	18		1609080043	20				100		pc.
N	22		1609080044	20				60		pc.
N	28		1609080045	20				40		pc.
N	35		1609080046	10				20		pc.
N	42		1609080047	4				16		pc.
N	54		1609080048	4				8		pc.
N	76,1		1609080049	1				1		pc.
N	88,9		1609080050	1				1		pc.
N	108		1609080040	1				1		pc.

coil
 bar
 pipes in tube
 bag
 carton box
 pallet
 N new
 available soon

* custom-made - lead time max 4 weeks | ** availability as agreed | *** while stock lasts

Elbow 90° 1.4301

GROUP: G

	Size [mm]	*	Code			UM
N	15		1609068333	20	110	pc.
N	18		1609068334	20	90	pc.
N	22		1609068335	20	50	pc.
N	28		1609068336	10	30	pc.
N	35		1609068337	10	20	pc.
N	42		1609068338	4	10	pc.
N	54		1609068339	2	8	pc.
N	76,1		1609068340	1	1	pc.
N	88,9		1609068341	1	1	pc.
N	108		1609068332	1	1	pc.



Plain end elbow 90° 1.4301

GROUP: G

	Size [mm]	*	Code			UM
N	15		1609068323	20	120	pc.
N	18		1609068324	20	60	pc.
N	22		1609068325	20	60	pc.
N	28		1609068326	10	30	pc.
N	35		1609068327	10	20	pc.
N	42		1609068328	4	10	pc.
N	54		1609068329	2	6	pc.
N	76,1		1609068330	1	1	pc.
N	88,9		1609068331	1	1	pc.
N	108		1609068322	1	1	pc.



Elbow 45° 1.4301

GROUP: G

	Size [mm]	*	Code			UM
N	15		1609068303	20	150	pc.
N	18		1609068304	20	120	pc.
N	22		1609068305	20	70	pc.
N	28		1609068306	10	40	pc.
N	35		1609068307	10	25	pc.
N	42		1609068308	4	16	pc.
N	54		1609068309	2	8	pc.
N	76,1		1609068310	1	1	pc.
N	88,9		1609068311	1	1	pc.
N	108		1609068302	1	1	pc.





Plain end elbow 45° 1.4301

GROUP: G

	Size [mm]	*	Code			UM
N	15		1609068313	20	150	pc.
N	18		1609068314	20	120	pc.
N	22		1609068315	20	60	pc.
N	28		1609068316	10	40	pc.
N	35		1609068317	10	25	pc.
N	42		1609068318	4	16	pc.
N	54		1609068319	2	8	pc.
N	76,1		1609068320	1	1	pc.
N	88,9		1609068321	1	1	pc.
N	108		1609068312	1	1	pc.



Tee 1.4301

GROUP: G

	Size [mm]	*	Code			UM
N	15		1609257126	20	80	pc.
N	18		1609257127	20	60	pc.
N	22		1609257128	20	40	pc.
N	28		1609257129	10	25	pc.
N	35		1609257130	10	15	pc.
N	42		1609257131	4	8	pc.
N	54		1609257132	2	6	pc.
N	76,1		1609257133	1	1	pc.
N	88,9		1609257134	1	1	pc.
N	108		1609257125	1	1	pc.



coil
 bar
 pipes in tube
 bag
 carton box
 pallet
 N new
 available soon

* custom-made - lead time max 4 weeks | ** availability as agreed | *** while stock lasts

Reducing tee 1.4301

GROUP: G



	Size [mm]	*	Code			UM
N	18 / 15 / 18		1609260133	20	60	pc.
N	22 / 15 / 22		1609260134	20	50	pc.
N	22 / 18 / 22		1609260135	20	50	pc.
N	28 / 15 / 28		1609260136	10	30	pc.
N	28 / 18 / 28		1609260137	10	30	pc.
N	28 / 22 / 28		1609260138	10	30	pc.
N	35 / 15 / 35		1609260139	10	20	pc.
N	35 / 18 / 35		1609260140	10	20	pc.
N	35 / 22 / 35		1609260141	10	20	pc.
N	35 / 28 / 35		1609260142	10	20	pc.
N	42 / 15 / 42		1609260143	4	12	pc.
N	42 / 18 / 42		1609260144	4	12	pc.
N	42 / 22 / 42		1609260145	4	12	pc.
N	42 / 28 / 42		1609260146	4	12	pc.
N	42 / 35 / 42		1609260147	4	12	pc.
N	54 / 15 / 54		1609260148	2	8	pc.
N	54 / 18 / 54		1609260149	2	8	pc.
N	54 / 22 / 54		1609260150	2	8	pc.
N	54 / 28 / 54		1609260151	2	8	pc.
N	54 / 35 / 54		1609260152	2	8	pc.
N	54 / 42 / 54		1609260153	2	8	pc.
N	76,1 / 22 / 76,1		1609260154	1	1	pc.
N	76,1 / 28 / 76,1		1609260155	1	1	pc.
N	76,1 / 35 / 76,1		1609260156	1	1	pc.
N	76,1 / 42 / 76,1		1609260157	1	1	pc.
N	76,1 / 54 / 76,1		1609260158	1	1	pc.
N	88,9 / 22 / 88,9		1609260159	1	1	pc.
N	88,9 / 28 / 88,9		1609260160	1	1	pc.
N	88,9 / 35 / 88,9		1609260161	1	1	pc.
N	88,9 / 42 / 88,9		1609260162	1	1	pc.
N	88,9 / 54 / 88,9		1609260163	1	1	pc.
N	88,9 / 76,1 / 88,9		1609260164	1	1	pc.
N	108 / 22 / 108		1609260126	1	1	pc.
N	108 / 28 / 108		1609260127	1	1	pc.
N	108 / 35 / 108		1609260128	1	1	pc.
N	108 / 42 / 108		1609260129	1	1	pc.
N	108 / 54 / 108		1609260130	1	1	pc.
N	108 / 76,1 / 108		1609260131	1	1	pc.
N	108 / 88,9 / 108		1609260132	1	1	pc.

 coil
  bar
  pipes in tube
  bag
  carton box
  pallet
 N new
  available soon

* custom-made - lead time max 4 weeks | ** availability as agreed | *** while stock lasts



Plain end reducer 1.4301

GROUP: G

	Size [mm]	*	Code							UM
N	18 / 15		1609221109	20				150		pc.
N	22 / 15		1609221110	20				140		pc.
N	22 / 18		1609221111	20				120		pc.
N	28 / 15		1609221112	20				70		pc.
N	28 / 18		1609221113	20				100		pc.
N	28 / 22		1609221114	20				80		pc.
N	35 / 15		1609221115	10				50		pc.
N	35 / 18		1609221116	10				50		pc.
N	35 / 22		1609221117	10				50		pc.
N	35 / 28		1609221118	10				45		pc.
N	42 / 15		1609221119	4				30		pc.
N	42 / 18		1609221120	4				30		pc.
N	42 / 22		1609221121	4				24		pc.
N	42 / 28		1609221122	4				24		pc.
N	42 / 35		1609221123	4				24		pc.
N	54 / 15		1609221124	4				16		pc.
N	54 / 18		1609221125	4				16		pc.
N	54 / 22		1609221126	4				16		pc.
N	54 / 28		1609221127	4				16		pc.
N	54 / 35		1609221128	4				16		pc.
N	54 / 42		1609221129	4				16		pc.
N	76,1 / 22		1609221144	1				-		pc.
N	76,1 / 28		1609221145	1				-		pc.
N	76,1 / 35		1609221146	1				-		pc.
N	76,1 / 42		1609221130	1				1		pc.
N	76,1 / 54		1609221131	1				1		pc.
N	88,9 / 22		1609221147	1				-		pc.
N	88,9 / 28		1609221148	1				-		pc.
N	88,9 / 35		1609221149	1				-		pc.
N	88,9 / 42		1609221150	1				-		pc.
N	88,9 / 54		1609221132	1				1		pc.
N	88,9 / 76,1		1609221133	1				1		pc.
N	108 / 22		1609221151	1				-		pc.
N	108 / 28		1609221152	1				-		pc.
N	108 / 35		1609221153	1				-		pc.
N	108 / 54		1609221106	1				2		pc.
N	108 / 76,1		1609221107	1				2		pc.
N	108 / 88,9		1609221108	1				2		pc.



Female elbow 90° 1.4301

GROUP: G

	Size [mm]	*	Code							UM
N	15 Rp1/2"		1609069008	20				90		pc.
N	18 Rp1/2"		1609069009	20				70		pc.
N	18 Rp3/4"		1609069013	10				90		pc.
N	22 Rp3/4"		1609069010	10				50		pc.
N	28 Rp1"		1609069011	10				30		pc.
N	35 Rp1 1/4"		1609069012	10				10		pc.

coil
 bar
 pipes in tube
 bag
 carton box
 pallet
 N new
 available soon

* custom-made - lead time max 4 weeks | ** availability as agreed | *** while stock lasts

Male elbow 90° 1.4301



GROUP: G

	Size [mm]	*	Code			UM
N	15 R1/2"		1609070025	20	80	pc.
N	18 R1/2"		1609070026	20	80	pc.
N	18 R3/4"		1609070027	10	80	pc.
N	22 R3/4"		1609070028	10	50	pc.
N	28 R1"		1609070029	10	30	pc.
N	35 R1 1/4"		1609070030	10	20	pc.
N	42 R1 1/2"		1609070031	2	10	pc.
N	54 R2"		1609070032	2	6	pc.



Female tee 1.4301 Inox



GROUP: G

	Size [mm]	*	Code			UM
N	15 Rp1/2"		1609257137	20	70	pc.
N	18 Rp1/2"		1609257138	20	50	pc.
N	18 Rp3/4"		1609257139	20	50	pc.
N	22 Rp1/2"		1609257140	20	40	pc.
N	22 Rp3/4"		1609257141	20	40	pc.
N	28 Rp1/2"		1609257143	10	30	pc.
N	28 Rp3/4"		1609257144	10	30	pc.
N	28 Rp1"		1609257142	10	30	pc.
N	35 Rp1/2"		1609257146	10	20	pc.
N	35 Rp3/4"		1609257147	10	20	pc.
N	35 R1 1/4"		1609257145	10	20	pc.
N	42 Rp1/2"		1609257149	4	16	pc.
N	42 Rp3/4"		1609257150	4	12	pc.
N	42 R1 1/2"		1609257148	4	12	pc.
N	54 Rp1/2"		1609257151	2	8	pc.
N	54 Rp3/4"		1609257153	2	8	pc.
N	54 Rp2"		1609257152	2	6	pc.
N	76,1 Rp3/4"		1609257155	1	1	pc.
N	76,1 Rp2"		1609257154	1	1	pc.
N	88,9 Rp3/4"		1609257157	1	1	pc.
N	88,9 Rp2"		1609257156	1	1	pc.
N	108 Rp3/4"		1609257136	1	1	pc.
N	108 Rp2"		1609257135	1	1	pc.



Male tee 1.4301

GROUP: G

	Size [mm]	*	Code			UM
N	15 R1/2"		1609257158	20	70	pc.
N	15 R3/8"		1609259012	20	-	pc.
N	18 R1/2"		1609257159	20	50	pc.
N	18 R3/4"		1609259013	20	-	pc.
N	22 R3/4"		1609257160	20	40	pc.
N	28 R1"		1609257161	10	30	pc.
N	35 R1 1/4"		1609257162	10	20	pc.



 coil
  bar
  pipes in tube
  bag
  carton box
  pallet
 N new
  available soon

* custom-made - lead time max 4 weeks | ** availability as agreed | *** while stock lasts

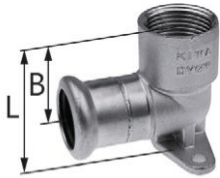

Female wallplate elbow 1.4301 - L = 41 mm

GROUP: G

Size [mm]	*	Code							UM
N 15 Rp $\frac{1}{2}$ "		1609286000					20	70	pc.

Note:
Size B = 28 mm.

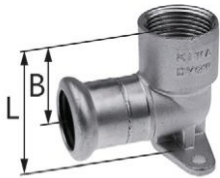

Female wallplate elbow 1.4301 - L = 44 mm

GROUP: G

Size [mm]	*	Code							UM
N 18 Rp $\frac{1}{2}$ "		1609286001					20	70	pc.

Note:
Size B = 28 mm.

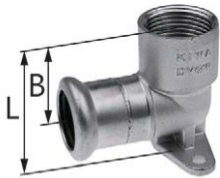

Female wallplate elbow 1.4301 - L = 52 mm

GROUP: G

Size [mm]	*	Code							UM
N 22 Rp $\frac{3}{4}$ "		1609286002					20	50	pc.

Note:
Size B = 33 mm.



Crossover 1.4301

GROUP: G

Size [mm]	*	Code							UM
N 15		1609178014					10	80	pc.
N 18		1609178015					10	50	pc.
N 22		1609178016					10	50	pc.
N 28		1609178020					10	-	pc.



Bend 90° 1.4301

GROUP: G

Size [mm]	*	Code							UM
N 15		1609011050					20	70	pc.
N 18		1609011051					20	50	pc.
N 22		1609011052					10	30	pc.
N 28		1609011053					10	20	pc.
N 35		1609011054					4	8	pc.
N 42		1609011055					2	4	pc.
N 54		1609011056					2	2	pc.
N 76,1		1609011057					1	1	pc.
N 88,9		1609011058					1	1	pc.
N 108		1609011049					1	1	pc.

coil bar pipes in tube bag carton box pallet **N** new available soon

* custom-made - lead time max 4 weeks | ** availability as agreed | *** while stock lasts

Stop end 1.4301

GROUP: G

Size [mm]	*	Code			UM
N 15		1609250063	20	80	pc.
N 18		1609250064	20	300	pc.
N 22		1609250065	20	150	pc.
N 28		1609250066	20	100	pc.
N 35		1609250067	10	75	pc.
N 42		1609250068	4	32	pc.
N 54		1609250069	4	24	pc.
N 76,1		1609250070	1	1	pc.
N 88,9		1609250071	1	1	pc.
N 108		1609250062	1	1	pc.



Flange PN16 1.4301

GROUP: G

Size [mm]	*	Code			UM
N 15 DN15		1609091030	1	15	pc.
N 18 DN15		1609091031	1	12	pc.
N 22 DN20		1609091032	1	9	pc.
N 28 DN25		1609091033	1	8	pc.
N 35 DN32		1609091034	1	5	pc.
N 42 DN40		1609091035	1	4	pc.
N 54 DN50		1609091036	1	2	pc.
N 76,1 DN65		1609091037	1	1	pc.
N 88,9 DN80		1609091038	1	1	pc.
N 108 DN100		1609091029	1	1	pc.

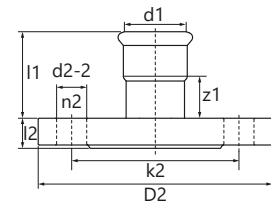

Code	D	k	b	d2	h	z	n2
1609091030	95	65	14	14	45	25	4
1609091031	95	65	14	14	47	27	4
1609091032	105	75	16	14	52	31	4
1609091033	115	85	16	14	56	34	4
1609091034	140	100	18	18	66	40	4
1609091035	150	110	18	18	74	44	4
1609091036	165	125	18	18	85	51	4
1609091037	185	145	20	18	132	78	4
1609091038	200	160	20	18	146	91	8
x 1609091029	220	180	20	18	169	100	8

 coil
  bar
  pipes in tube
  bag
  carton box
  pallet
 N new
  available soon

* custom-made - lead time max 4 weeks | ** availability as agreed | *** while stock lasts

Accessories



Plug

GROUP: I

	Size [mm]	*	Code		UM
N	15		2141183000	2000	pc.
N	18		2141183001	2000	pc.
N	22		2141183002	2000	pc.
N	28		2141183003	2000	pc.
N	35		2141183004	2000	pc.
N	42		2141183005	1000	pc.
N	54		2141183006	500	pc.

 coil
  bar
  pipes in tube
  bag
  carton box
  pallet
 N new
  available soon

* custom-made - lead time max 4 weeks | ** availability as agreed | *** while stock lasts

Tools

Roller cutter for pipes REMS RAS St

GROUP: K

Range [mm]	*	Code		UM
15-54		1948267025	1	pc.
35-108		1948267027	1	pc.



Cutting wheel for roller cutter REMS St

GROUP: K

Range [mm]	*	Code		UM
15-108		1941267037	1	pc.

Intended for roller cutters, codes: 1948267025, 1948267027.



Roller cutter for pipes REMS RAS Mini S

GROUP: K

Range [mm]	*	Code		UM
15-28		1900267003	1	pc.

Note:
The set includes a cutting wheel.



Roller cutter for pipes REMS RAS S

GROUP: K

Range [mm]	*	Code		UM
15-28		1900267001	1	pc.

Note:
The set includes a cutting wheel.



Cutting wheel for roller cutter REMS RAS

GROUP: K

Range [mm]	*	Code		UM
15-28		1900267002	1	pc.

Intended for roller cutters, codes: 1900267003, 1900267001.



Cordless pipe cutter REMS Akku-Nano

GROUP: K

Range [mm]	*	Code		UM
15-28		1948183003	1	pc.

Note:
The set includes a cutting wheel.



 coil  bar  pipes in tube  bag  carton box  pallet **N** new  available soon

* custom-made - lead time max 4 weeks | ** availability as agreed | *** while stock lasts



Cutting wheel for roller cutter REMS Nano

GROUP: K

Range [mm]	*	Code		UM
10-35		1978267000	1	pc.

Intended for Cordless pipe cutting machine code 1948183003.



Pipe cutting machine REMS Cento

GROUP: K

Range [mm]	*	Code		UM
22-108		1948183001	1	pc.

Note:
The set includes a cutting wheel.



Pipe cutting machine REMS DueCento

GROUP: K

Range [mm]	*	Code		UM
54-108		1948267034	1	pc.

Note:
The set does not include a cutting wheel.
In operating range 54-108, use additional guide rollers with code 1900267000.
Guide rollers must be purchased separately.



Cutting wheel for pipe cutting machine REMS Cento/DueCento

GROUP: K

Range [mm]	*	Code		UM
22-108		1941267041	1	pc.

Intended for pipe cutting machines, codes: 1948183001, 1948267034.



Guide roller insert for pipe cutting REMS DueCento

GROUP: K

Range [mm]	*	Code		UM
54-108		1900267000	1	pc.

Note:
Intended for pipe cutting machine, code: 1948267034.



Pipe support for cutting machine REMS Cento

GROUP: K

	*	Code		UM
		1948267029	1	pc.

coil bar pipes in tube bag carton box pallet **N** new available soon

* custom-made - lead time max 4 weeks | ** availability as agreed | *** while stock lasts

Deburrer for metal pipes REMS REG

GROUP: K

Range [mm]	*	Code		UM
15-54		1948267015	1	pc.



Tool set - deburrer and roller cutter

GROUP: K

Range [mm]	*	Code		UM
15-54	*	1948267023	1	set

Each set includes:

- 1948267025 - roller cutter for pipes 12-54 mm,
- 1948267015 - deburrer for pipes 12-54 mm,
- 1941267129 - case.



Tool set - KAN-therm Mini battery press tool + "M" profile jaws

GROUP: K

Range [mm]	*	Code		UM
15-28		1936055009	1	pc.

Each set includes:

- 1936055008 - KAN-therm Mini press tool - 1 pc.,
- 1936267278 - jaws SBM M15 - 1 pc.,
- 1936267279 - jaws SBM M18 - 1 pc.,
- 1936267280 - jaws SBM M22 - 1 pc.,
- 1936267282 - jaws SBM M28 - 1 pc.,
- 1967267051 - battery RAML1 10,8 V Li-Ion 1,5 Ah - 2 pcs.,
- 1967267024 - charger LGML1 ~230 V 35 W,
- case - 1 pc.



KAN-therm AC 3000 electric press tool

GROUP: K

Range [mm]	*	Code		UM
15-54		1936267239	1	pc.

Note:

The press tool is sold in a case.



KAN-therm DC 4000 battery press tool

GROUP: K

Range [mm]	*	Code		UM
15-54		1936267238	1	pc.

Note:

The press tool is sold with a battery, charger and case.



Charger for KAN-therm DC 4000 battery press tool

GROUP: K

Version	*	Code		UM
10,8-36 V		1936267267	1	pc.



 coil  bar  pipes in tube  bag  carton box  pallet **N** new  available soon

* custom-made - lead time max 4 weeks | ** availability as agreed | *** while stock lasts



Battery for KAN-therm DC 4000 press tool

GROUP: K

Version	*	Code		UM
N 18 V / 4 Ah		1936267266	1	pc.



KAN-therm "M" profile press jaws

GROUP: K

Size [mm]	*	Code		UM
N 15		1936267249	1	pc.
N 18		1936267250	1	pc.
N 22		1936267251	1	pc.
N 28		1936267252	1	pc.
N 35		1936267253	1	pc.

Note:
The jaws work with KAN-therm: AC 3000, DC 4000 drives.



KAN-therm "M" profile collar

GROUP: K

Size [mm]	*	Code		UM
N 42		1936267283	1	pc.
N 54		1936267284	1	pc.

Note:
Use KAN-therm "M" profile collar jaws with KAN-therm ZBS1 adapter for KAN-therm press tools, AC 3000, DC 4000.



ZBS1 adapter for KAN-therm "M" profile collar jaws

GROUP: K

Size [mm]	*	Code		UM
N 42 - 54		1936267285	1	pc.

Note:
Use KAN-therm "M" profile collar jaws with KAN-therm ZBS1 adapter for KAN-therm press tools: AC 3000, DC 4000.



REMS Power-Press ACC electric press tool

GROUP: K

Range [mm]	*	Code		UM
15-54		1936267219	1	pc.

Note:
The press tool is sold with a case.
The set does not include jaws.



REMS Power-Press SE Basic Pack electric press tool

GROUP: K

Range [mm]	*	Code		UM
15-54		1936267160	1	pc.

Note:
The press tool is sold with a case.
The set does not include jaws.

REMS Akku Press battery press tool

GROUP: K

Range [mm]	*	Code		UM
15-54		1936267152	1	pc.

Note:

The press tool is sold with a battery, charger and case.
The set does not include jaws.



REMS "M" profile press jaws

GROUP: K

Size [mm]	*	Code		UM
15		1948267048	1	pc.
18		1948267052	1	pc.
22		1948267056	1	pc.
28		1948267061	1	pc.
35		1948267065	1	pc.
42		1948267067	1	pc.
54		1948267069	1	pc.

Note:

The jaws work with Power-Press SE, Akku-Press, Power-Press ACC drives.



Set of REMS "M" profile press jaws

GROUP: K

Range [mm]	*	Code		UM
42-54		1948267130	1	set

Each set includes:

- 1948267067 - jaws "M" to diameter 42 mm,
- 1948267069 - jaws "M" to diameter 54 mm,
- case.

Jaws work with Power-Press SE, Akku-Press, Power-Press ACC drives.



REMS tool set - electric Power-Press SE press tool and "M" profile jaws

GROUP: K

Range [mm]	*	Code		UM
15-35		1948267033	1	set

Each set includes:

- 1936267160 - electric press tool REMS Power-Press SE,
- 1948267048 - jaws "M" to diameter 15 mm,
- 1948267052 - jaws "M" to diameter 18 mm,
- 1948267056 - jaws "M" to diameter 22 mm,
- 1948267061 - jaws "M" to diameter 28 mm,
- 1948267065 - jaws "M" to diameter 35 mm,
- case.



Novopress tool set - ACO103 BT battery press tool + "M" profile jaws

GROUP: K

Range [mm]	*	Code		UM
15-28	*	1948055008	1	pc.

Each set includes:

- battery press tool - 1 pc.,
- 1948267093 - jaws M15 for press tool - 1 pc.,
- 1948267095 - jaws M18 for press tool - 1 pc.,
- 1942121002 - jaws M22 for press tool - 1 pc.,
- 1948267097 - jaws M28 for press tool - 1 pc.,
- 1938267047 - charger - 1 pc.,
- 1938267002 - battery 2 Ah - 2 pcs.,
- case.



 coil  bar  pipes in tube  bag  carton box  pallet  new  available soon

* custom-made - lead time max 4 weeks | ** availability as agreed | *** while stock lasts



Novopress EFP203 electric press tool

GROUP: K

Range [mm]	*	Code		UM
15-54		1948267210	1	pc.

Note:
The press tool is sold with a plastic case.



Novopress ACO203XL BT press tool

GROUP: K

Range [mm]	*	Code		UM
15-108		1948267181	1	pc.

Each set includes:
 •battery press tool - 1 pc.,
 •battery 18 V / 5.0 Ah Li-Ion Milwaukee - 2 pcs.,
 •charger - 1 pc.,
 •pubricant - 1 pc.,
 •plastic case.



Novopress PB2 "M" profile press jaws

GROUP: K

Size [mm]	*	Code		UM
15		1948267135	1	pc.
18		1948267137	1	pc.
22		1948267139	1	pc.
28		1948267141	1	pc.
35		1948267143	1	pc.

Note:
The jaws work with EFP203 and ACO203XL drives.



Novopress "M" profile Snap On collar

GROUP: K

Size [mm]	*	Code		UM
42		1948267119	1	pc.
54		1948267121	1	pc.
66,7	*	1948267089	1	pc.
76,1		1948267145	1	pc.
88,9		1948267044	1	pc.
108		1948267038	1	pc.

Note:
 Use jaws for diameters 42, 54 mm with adapter ZB203 for ACO203XL.
 Use jaws for diameters 66,7, 76,1 and 88,9 mm with adapter ZB221 for ACO203XL.
 Use the jaw with a diameter of 66,7 mm with adapter ZB323 for ECO301.
 Use the jaw with a diameter of 108 mm with adapter ZB221 and ZB222 for ACO203XL.

HP Snap On collar for Novopress ECO301, ACO203XL, EFP203

GROUP: K

Size [mm]	*	Code		UM
35	*	1948267124	1	pc.
42	*	1948267126	1	pc.
54	*	1948267128	1	pc.

Note:

Jaws for diameters 35-54 mm with ECO301 press tool use with ZB303 adapter.

Jaws for diameters 35-54 mm with ACO203XL and EFP203 crimping tool use with ZB203 adapter.

Do not use jaw 54 with the ACO203XL and EFP203 crimper to join KAN-therm Inox system pipes (1.4404 and 1.4521) with a diameter of 54 mm.



Novopress ZB203 adapter

GROUP: K

Range [mm]	*	Code		UM
35-54		1948267000	1	pc.

Note:

Adapter for EFP203 and ACO203XL drives.

Press: 50-63 mm.

Steel & Inox: 35-54 mm.

Copper: 42-54 mm.



Novopress ZB221 Adapter

GROUP: K

Range [mm]	*	Code		UM
66,7-108		1948267005	1	pc.

Note:

Adapter for ACO203XL drive.

For a diameter of 108 mm, adapter ZB221 is used to make the first crimp, and adapter ZB222 for the second crimp.



Novopress ZB222 Adpater

GROUP: K

Range [mm]	*	Code		UM
66,7-108		1948267007	1	pc.

Note:

Adapter for ACO203XL drive.

For a diameter of 108 mm, adapter ZB221 is used to make the first crimp, and adapter ZB222 for the second crimp.



Novopress ACO403 battery press tool

GROUP: K

Range [mm]	*	Code		UM
76,1-108		1948267209	1	pc.

Each set includes:

- battery press tool - 1 pc.,
- battery 18 V / 5.0 Ah Li-Ion Milwaukee - 2 pcs.,
- charger - 1 pc.,
- lubricant - 1 pc.,
- plastic case





Novopress "M" profile HP collar

GROUP: K

Size [mm]	*	Code		UM
76,1	*	1948267100	1	pc.
88,9	*	1948267102	1	pc.
108	*	1948267098	1	pc.

Note:

The jaws work with ACO401 and ACO403 drives.



Install your **future**

THE PRODUCTS WITH THE LABEL KAN-therm ARE DISTRIBUTED TO 68 COUNTRIES IN THE WORLD.

The distribution network covers Europe, a large part of Asia and also reaches Africa and America.



HEADQUARTERS

KAN Group

Zdrojowa St. 51, 16-001 Kleosin, Poland.

tel. +48 85 74 99 200

e-mail: kan@kan-therm.com

www.kan-therm.com

Complete multipurpose installation system consisting of modern, mutually complementary technical solutions for pipe water distribution, heating and cooling installations, as well as technological and fire extinguishing ones.

ultra**LINE**

ultra**PRESS**

PP

Steel

Inox

Groove

Copper, Copper Gas

XPress Sprinkler

**Surface heating and cooling,
automation**

**Football
Stadium installations**

**Cabinets
and manifolds**

